



3-conductor through terminal block; suitable for Ex e II applications

Item No.: 2002-1301



3-conductor through terminal block; suitable for Ex e II applications

Marking

RoHS ✓
Compliant

Business data

Supplier	WAGO
Item no.	2002-1301
GTIN / EAN	4017332999229
Content	1
Order amount	100
Customer item number	

Notes

Technical data

Miscellaneous

Total number of connection points	3
Total number of potentials	1
Color	gray
Ratings per	IEC/EN 60947-7-1
Rated voltage (III / 3) [V]	800 [V]
Rated impulse voltage (III / 3) [kV]	8 [kV]

Technical data	
<i>Rated current [A]</i>	<i>24 [A]</i>
<i>Rated current (2) [A]</i>	<i>32 [A]</i>
<i>Rated voltage EN (Ex e II) [V]</i>	<i>550 [V]</i>
<i>Rated current (Ex e II) [A]</i>	<i>22 [A]</i>
<i>Rated current (Ex e II) with jumper [A]</i>	<i>20 [A]</i>
<i>Number of levels</i>	<i>1</i>
<i>Connection technology</i>	<i>Push-in CAGE CLAMP®</i>
<i>Number of connection points connector</i>	<i>3</i>
<i>Actuation type</i>	<i>Operating tool</i>
<i>Connectable conductor materials</i>	<i>Copper</i>
<i>Nominal cross section</i>	<i>2.5 mm²</i>
<i>Solid conductor</i>	<i>0.25 ... 4 mm² / 22 ... 12 AWG</i>
<i>Solid conductor, push-in termination</i>	<i>0.75 ... 4 mm² / 18 ... 12 AWG</i>
<i>Fine-stranded conductor</i>	<i>0.25 ... 4 mm² / 22 ... 12 AWG</i>
<i>Fine-stranded conductor with ferrule, push-in termination, m</i>	<i>0.75 mm² / 18 AWG</i>
<i>Strip length</i>	<i>10 ... 12 mm / 0.39 ... 0.47 Inch</i>
<i>Type of wiring</i>	<i>Front-entry wiring</i>
<i>Design</i>	<i>horizontal</i>
<i>Marking level</i>	<i>Center/side marking</i>
<i>Insulating material</i>	<i>Polyamide 66 (PA 66)</i>
<i>Fire load [MJ]</i>	<i>0.104 [MJ]</i>
<i>Weight [g]</i>	<i>6.07 [g]</i>
<i>Width</i>	<i>5.2 mm / 0.205 Inch</i>
<i>Height from upper-edge of DIN-35 rail</i>	<i>32.9 mm / 1.295 Inch</i>
<i>Depth</i>	<i>59.2 mm / 2.33 Inch</i>
<i>Type of mounting</i>	<i>DIN-35 x 15 carrier rail</i>

Images & drawings

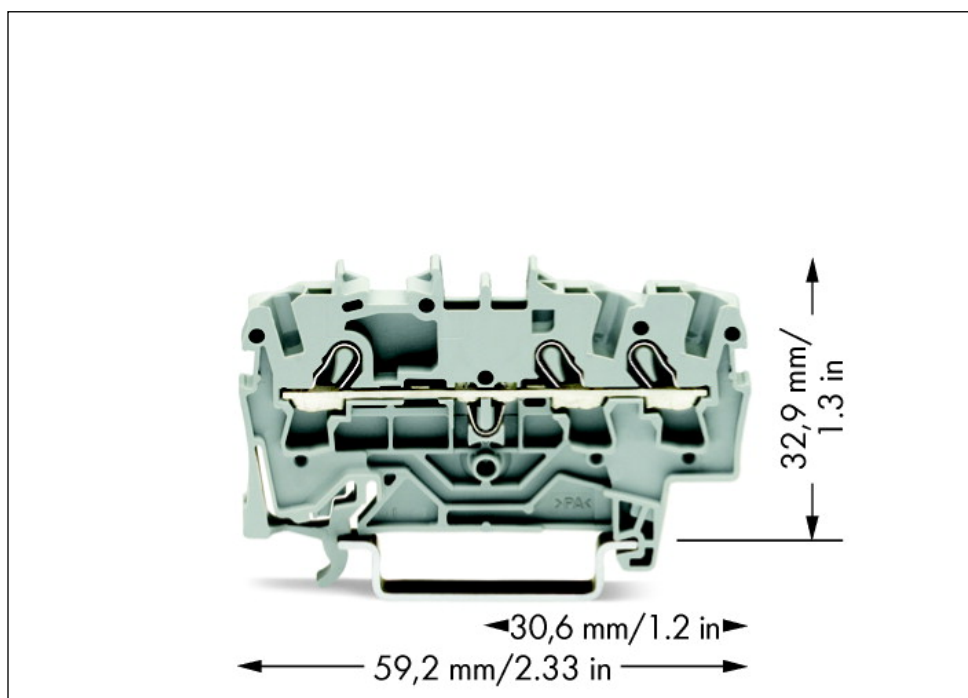
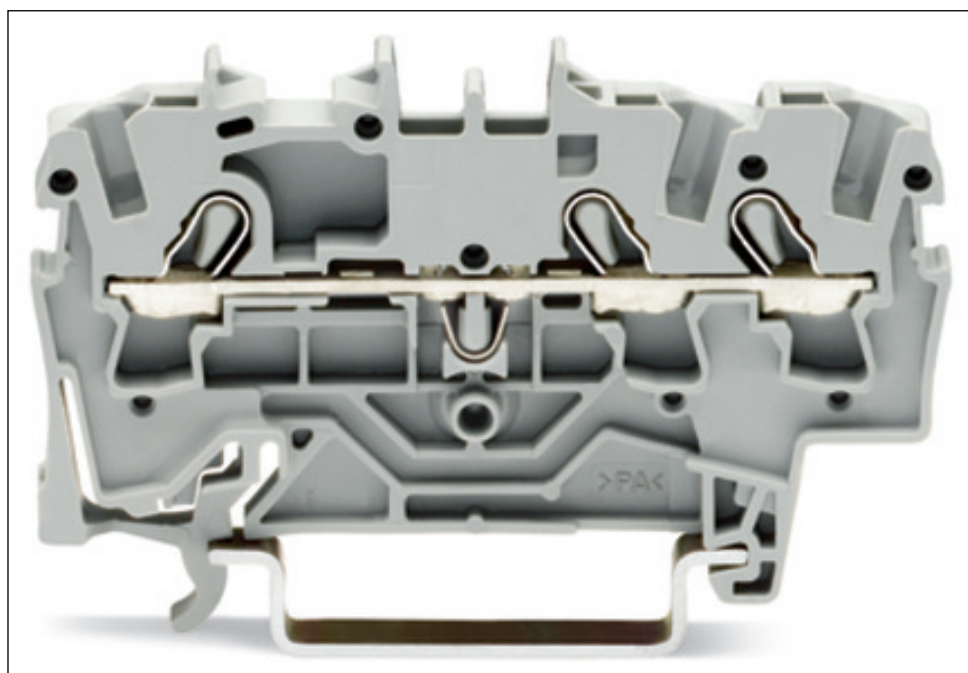

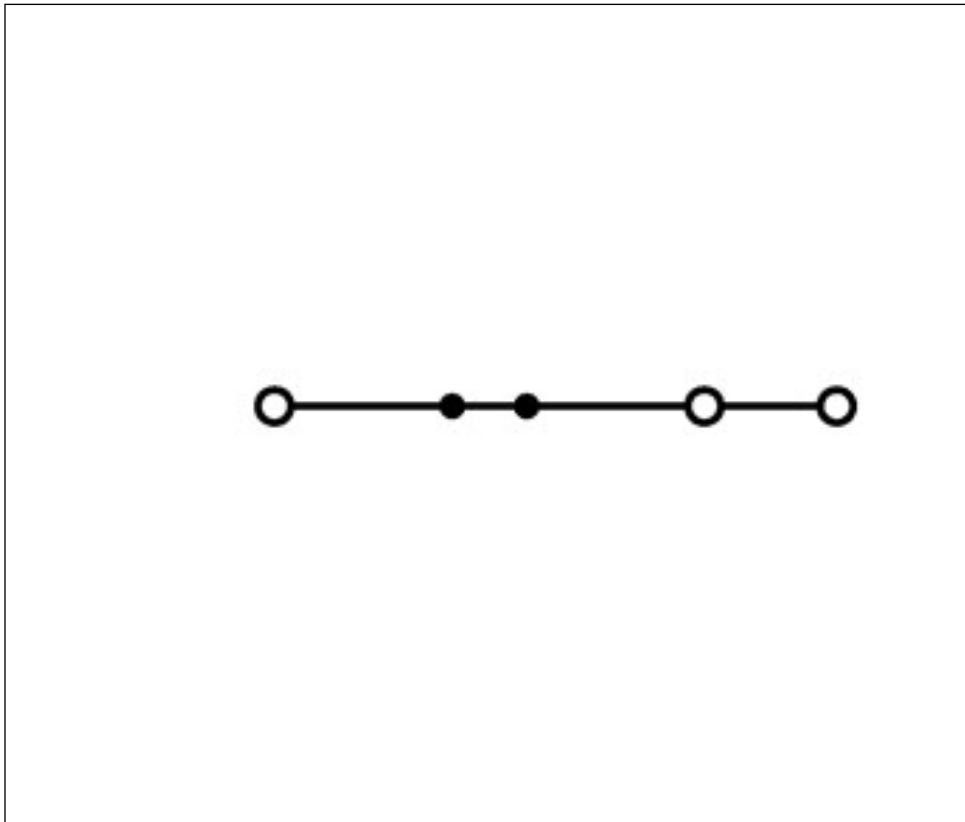

Address

WAGO Kontakttechnik GmbH & Co. KG

Hansastr. 27

32423 Minden

Telefon: 0571/887-0

Fax: 0571/887-169

<http://www.wago.com>

© WAGO Kontakttechnik GmbH & Co. KG

Technische Änderungen und Irrtümer vorbehalten.